

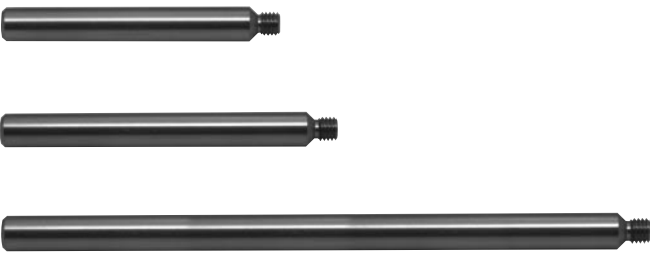

Fuß/Säulenelement



Länge	Best.-Nr.	Farbe	Preis/St.	Menge	Summe
80 mm	01/80		7,11		
100 mm	01/100		7,93		
200 mm	01/200		14,57		

Verlängerung



Länge	Best.-Nr.	Farbe	Preis/St.	Menge	Summe
100 mm	02/100		13,81		
200 mm	02/200		18,11		

**Alu-Basissockel 1,
Ø 30 mm**



Höhe	Best.-Nr.	Farbe	Preis/St.	Menge	Summe
30 mm	03/30		28,82		

**Alu-Basissockel 2,
Ø 30 mm**



Höhe	Best.-Nr.	Farbe	Preis/St.	Menge	Summe
30 mm	04/30		32,91		

**Aufsatzknoten, schwenkbar,
Ø 30 mm**



Höhe	Best.-Nr.	Farbe	Preis/St.	Menge	Summe
30 mm	05/30		34,81		

**Holz-Basissockel,
Ø 80 mm**



Höhe	Best.-Nr.	Farbe	Preis/St.	Menge	Summe
80 mm	10/80		14,53		
Gewinde- buchse	10/01		5,47		

Farbspektrum Alu

alu	rot	grün	titan	gelb	schwarz	blau	orange
01	02	03	04	05	06	07	08

Farbspektrum Holz

Buche	rot	gelb	orange
01	02	03	04

Bestell-Telefon (04954) 954704 • Bestell-Telefax (04954) 954778 • Bestell-Mail info@optikdesign-sachs.de

**Präsentations-
ebene, Glas,
Ø 200 mm**



	Best.-Nr.	Farbe	Preis/St.	Menge	Summe
komplett	01/1		57,75		

**Präsentations-
ebene, Glas,
Ø 200 mm**



	Best.-Nr.	Farbe	Preis/St.	Menge	Summe
komplett	01/2		57,75		

**Präsentations-
ebene, Glas,
200x200 mm**



	Best.-Nr.	Farbe	Preis/St.	Menge	Summe
komplett	02/1		57,75		

**Präsentations-
ebene, Glas,
200x200 mm**



	Best.-Nr.	Farbe	Preis/St.	Menge	Summe
komplett	02/2		57,75		

**Präsentations-
ebene**

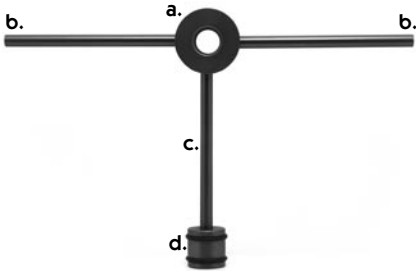

	Best.-Nr.	Farbe	Preis/St.	Menge	Summe
komplett	06		38,19		
Fixierring	06a		12,12		
Bügelaufl.	06b		5,06*		
Steghalter	06c		7,81		
Stegaufll.	06d		8,14		

* 2 Stück

Bestell-Beispiel
für Alu-Basissockel 1, rot: Best.-Nr. (03/30) + Farb-Nr. (02) = **03/30/02**

Name, Vorname

Firma

Straße, Hausnummer

PLZ, Ort

Telefon, Telefax

Farbspektrum Alu

alu	rot	grün	titan	gold	schwarz	blau	orange
01	02	03	04	05	06	07	08